

DETAIL 3 POLE TOP

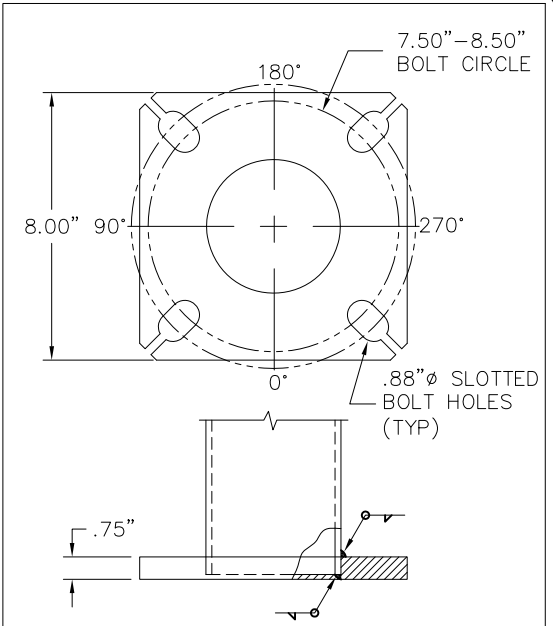

DETAIL 1 BASE PLATE

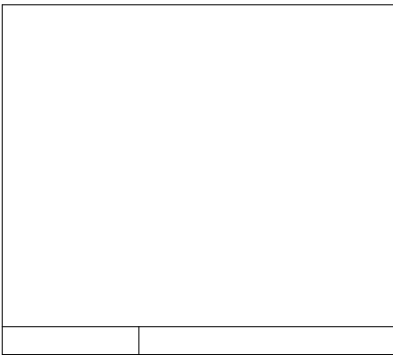

DETAIL 2 ANCHOR BOLT

- 1) HARDWARE TO BE GALVANIZED TO: ASTM A153
- 2) ANCHOR BOLTS SHALL BE FULLY GALVANIZED PER ASTM A153.
- 3) ALL WELDING TO CONFORM TO: AWS D1.1 MOST RECENT EDITION.
- 4) FABRICATION MEETS AISC (AMERICAN INSTITUTE OF STEEL CONSTRUCTION) QUALITY CERTIFICATION.
- 5) PROVISIONS FOR GROUNDING LOCATED AT BASE HAND HOLE.
- 6) VIBRATION DISCLAIMER: ALTHOUGH RARE, VIBRATIONS SEVERE ENOUGH TO CAUSE DAMAGE CAN OCCASIONALLY OCCUR IN STRUCTURES OF ALL TYPES. BECAUSE THEY ARE INFLUENCED BY MANY INTERACTING VARIABLES, VIBRATIONS ARE GENERALLY UNPREDICTABLE. THE USER'S MAINTENANCE PROGRAM SHOULD INCLUDE OBSERVATION FOR EXCESSIVE VIBRATION AND EXAMINATION FOR ANY STRUCTURAL DAMAGE. ALL WARRANTY EXCLUDES FATIGUE FAILURE OR SIMILAR PHENOMENA RESULTING FROM INDUCED VIBRATION, HARMONIC OSCILLATION OR RESONANCE ASSOCIATED WITH MOVEMENT OF AIR CURRENTS AROUND THE POLE.

LOADING DATA							
DESIGN CRITERIA:	2009 AASHTO LTS-5						
WIND SPEED(mph) 3 SEC GUST	90	100	110	120	130	140	150
EPA FT²	20.8	16.6	15.2	12.6	10.4	8.8	6.0
WEIGHT (lbs)	150	150	150	150	150	150	150
FINISH							
TBD							

MATERIAL DATA	
COMPONENT	ASTM
POLE SHAFT	A500 GR.B
BASE PLATE	A36
ANCHOR BOLTS	F1554 GR.55
MISC. STEEL	A36

POLE DIMENSION DATA						
TYPE	DESIGN	POLE LENGTH (FT)	BASE DIA. (IN)	TOP DIA. (IN)	GAUGE OR THK (IN)	WEIGHT (LBS)
	RNS-10-40-11-AB	10	4.00	4.00	11-GA (.120")	70

DETAIL GENERAL NOTES



AMERICAN LITE POLE  
2800 S. HULEN, SUITE 200  
FORT WORTH, TX 76109  
817-924-3682 PH.  
817-924-7049 FAX

**\*\* CONFIDENTIAL \*\***

THE INFORMATION CONTAINED IN THIS DRAWING IS PROPRIETARY AND CONFIDENTIAL. UNAUTHORIZED DUPLICATION OR DISSEMINATION OF THIS DOCUMENT IS STRICTLY PROHIBITED WITHOUT PRIOR WRITTEN NOTICE FROM AMERICAN LITE POLE.

REV. DATE BY REVISION DESCRIPTION

PROJECT NAME:

DESCRIPTION:  
**ROUND STRAIGHT STEEL ANCHOR BASE**  
**10' x 4.0" x 11 GA**

PO NUMBER: DATE: DWG BY:

QUOTE NUMBER: SCALE: QTY: CHKD BY:

DRAWING NUMBER: RNS-10-40-11-AB REV: